

WXD — 1504X

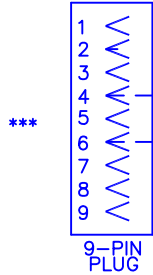

CAUTION: Relays utilize 22VDC coils with AC to DC rectifiers. Do not use relay without rectifier. Replace with factory authorized parts only.

24VAC Class 2 power source must not exceed 26.4VAC under any primary input voltage condition per UL/NEC

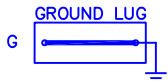

**** FIELD CONNECTION 230VAC 3Ø

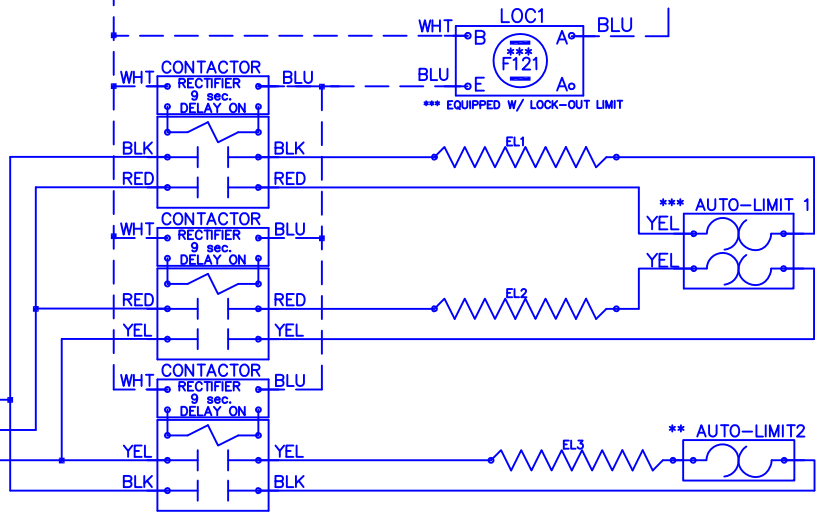
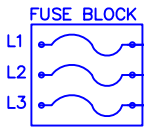

Model	WXD-1504X
Serial #	_____
Tag -	_____
Kilowatts	15.0
Volts-Ph-Hz	240/3/△/60
Control Volts	24.0
Steps	2
Heater Amps	36.1
Fuse Size	50

NOTE :
 CAUTION - Contactors utilize 22-28VDC coils with AC to DC rectifiers. Do not use contactor without rectifier. Replace with factory authorized parts only.
 -Contactor must always utilize AC-DC Rectifier with Time Delay as shown.
 ** Replace Auto-Reset with Therm-O-Disc type 60TX11-L145/2PL-145.
 *** Replace Lock-Out Limit with 36TXV12 - 121° C To Reset Lock-Out Limit, Cycle Power To The Heater With Either The Circuit Breaker Or The Thermostat.
 **** 24VAC, Class 2 power source must not exceed 26.4VAC under any primary input voltage condition per UL/NEC.
 ***** Power supply wiring per NEC & Local Codes. Suitable for at least 75°C. Use copper conductor wiring only.

Control Wiring _____
 Power Wiring _____
 Field Wiring _____

WXD1504X

Rev. by : M. REEVES
 Date : 05/10/21

WARREN TECHNOLOGY